

Pressed male reducers

RPCL

[Download Wentyle](#)
[Download AlnorCAM](#)
[Buy via B2B](#)



Dimensions

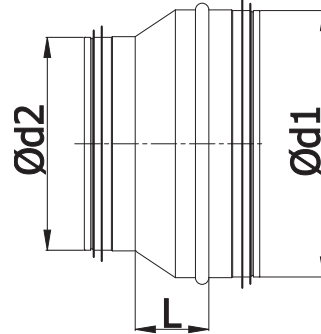

Description

RPCL – Pressed symmetric male-male reducer with EPDM gaskets.

Ød₁ and Ød₂ – fits SPR ducts.

Example identification

Product code: RPCL - aaa - bbb

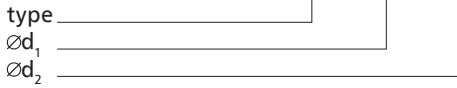

Ød _{1 rated} [mm]	Ød _{2 rated} [mm]	L [mm]	weight [kg]
100	80	18	0,20
125	80	28	0,20
	100	22	0,20
140	100*	30	0,20
	125	30	0,20
150	100	35	0,20
	125	30	0,20
	140	30	0,20
160	80	48	0,30
	100	37	0,30
	125	26	0,20
	140	30	0,30
	150	30	0,30
	160	30	0,30
180	125*	40	0,30
	140*	30	0,30
	150*	30	0,30
	160	30	0,30
200	100	58	0,40
	125	46	0,40
	140*	40	0,30
	150	35	0,30
	160	26	0,30
	180*	30	0,30
224	150*	50	0,40
	160*	50	0,40
	180*	30	0,40
	200	30	0,40

Dimensions

$\varnothing d_{1, \text{rated}}$ [mm]	$\varnothing d_{2, \text{rated}}$ [mm]	L [mm]	weight [kg]
250	125	70	0,50
	150	60	0,50
	160	53	0,50
	180*	50	0,40
	200	31	0,60
	224*	50	0,50
	280	160*	80
180*		70	0,60
200*		60	0,60
224*		40	0,60
300		200*	70
	224*	60	0,70
	250*	30	0,60
	280*	30	0,70
	315	160	88
180*		90	0,80
200		68	0,70
224*		60	0,70
250		43	0,70
280*		40	0,70
300*		38	0,70
355	200*	110	1,10
	224*	90	1,00
	250*	70	1,00
	315*	30	0,90
400	200*	140	1,50
	224*	120	1,40
	250*	100	1,30
	315*	60	1,30
	355*	30	1,20
450	250*	140	2,00
	280*	110	1,90
	300*	100	1,90
	315*	90	1,80
	355*	60	1,70
400*	40	1,70	

$\varnothing d_{1, \text{rated}}$ [mm]	$\varnothing d_{2, \text{rated}}$ [mm]	L [mm]	weight [kg]
500	250*	128	2,20
	300*	140	2,40
	315*	120	2,20
	355*	100	2,20
	400*	70	2,10
	450*	40	2,10
	560	315*	170
355*		140	2,80
400*		110	2,70
450*		80	2,60
500*		75	2,60
600	400*	130	3,10
	450*	100	3,00
	500*	70	2,70
	560*	30	2,40
	630	315*	160
400*		140	3,30
450*		120	3,30
500*		80	3,00
560*		75	2,90
600*		30	2,50

* Fabricated, the remaining entirely pressed.

Pressed reducers

RPCL/RPCFL/RPC/RPCF

Technical Data

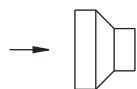

1 reduction stage

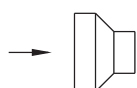
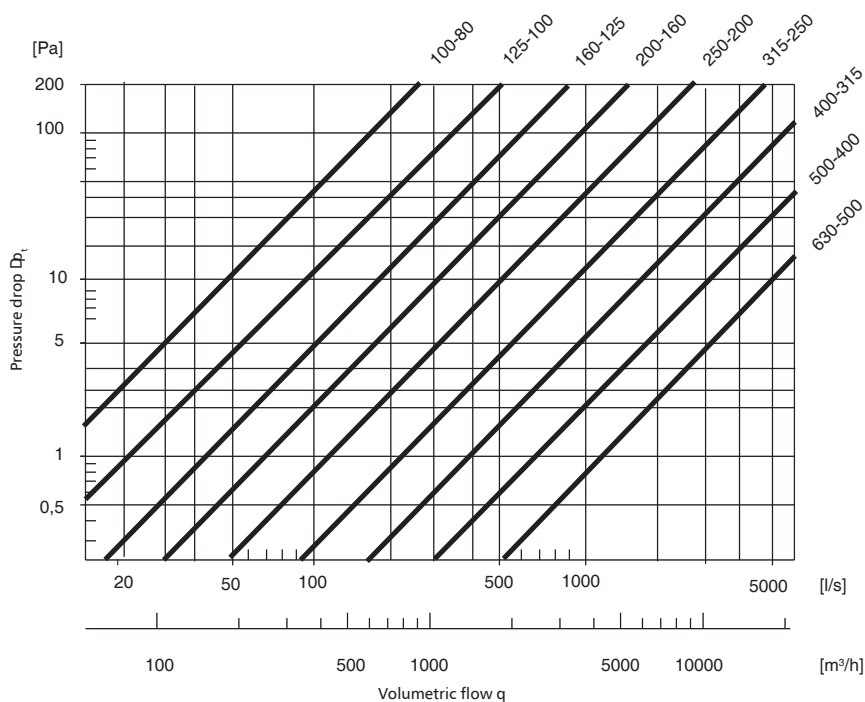

2 reduction stage

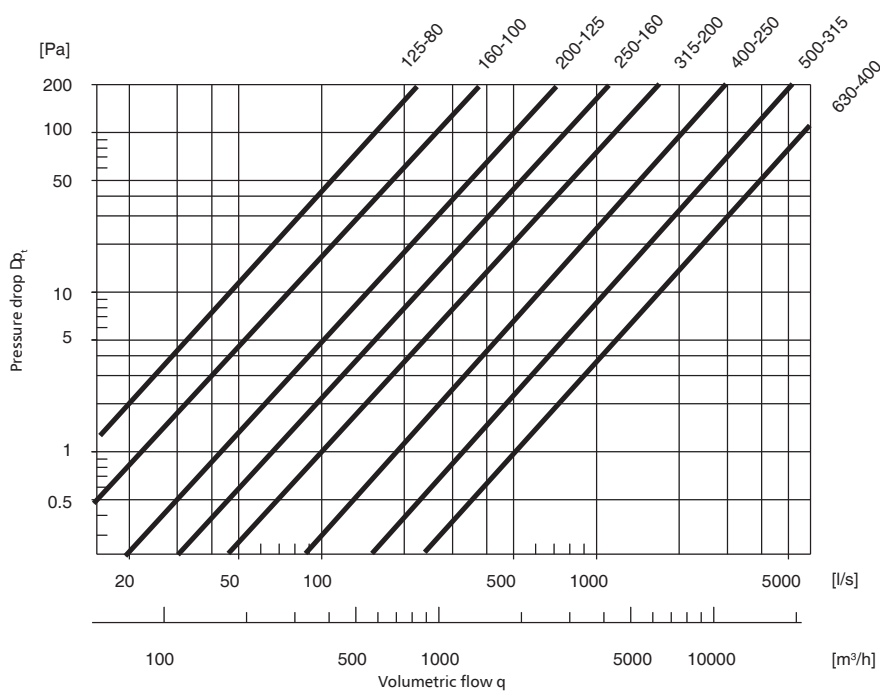

Technical Data

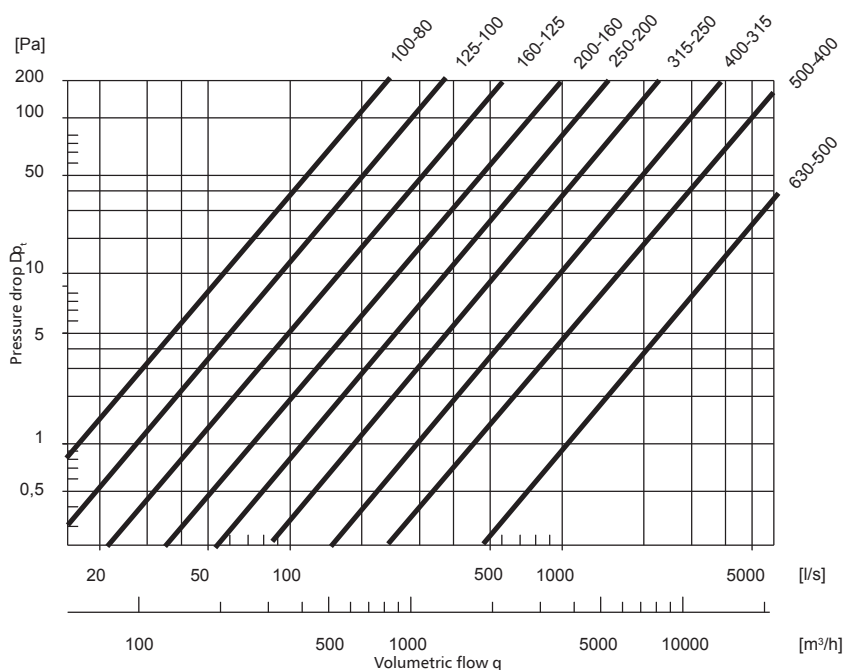
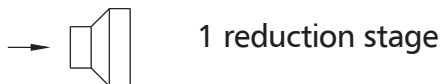
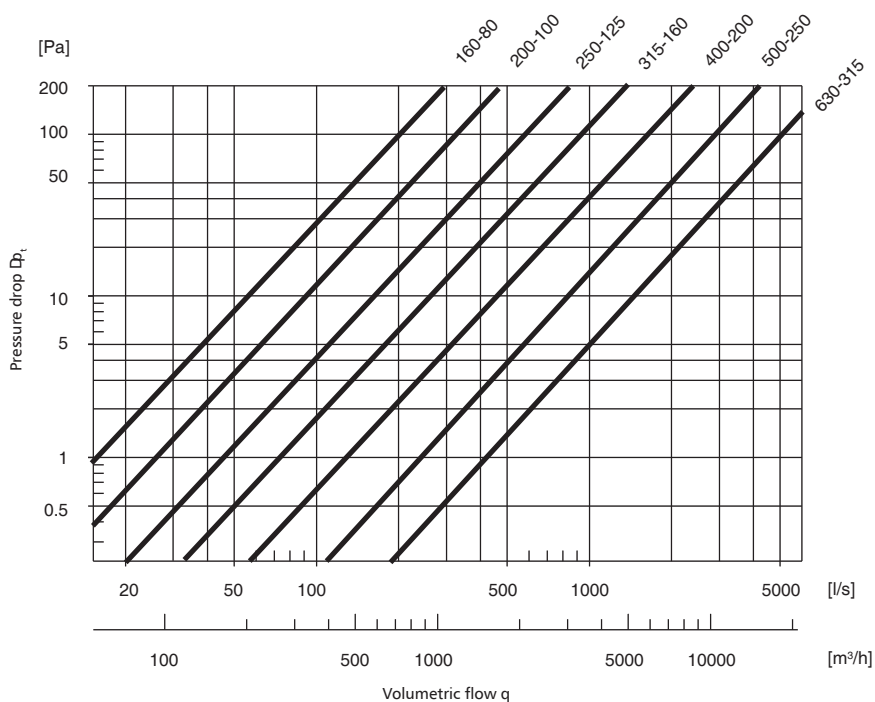
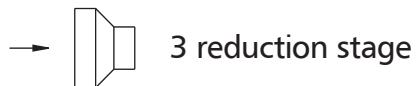

Pressed reducers

RPCL/RPCFL/RPC/RPCF/RPCN/RPCNR

[Download Wentyle](#)
[Download AlnorCAM](#)
[Buy via B2B](#)

Technical Data

