

Saddle

PSU



Description

Pressed saddle with aerodynamic flow radius facing the branch.

Some PSUs are pressed with one and the same tool, and fit several dimensions of main pipe.

Pressure drop, see graphs on page 109.

Dimensions

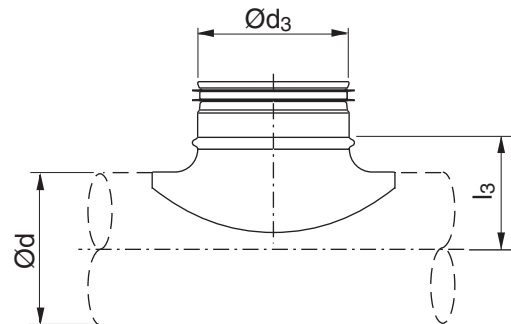

Ød nom	Ød ₃ nom	l ₃ mm	m kg
63	63	42	0,09
80	63	50	0,09
80	80	52	0,13
100	63	60	0,09
100	80	60	0,14
100	100	65	0,18
112	63	66	0,09
112	80	68	0,13
112	100	71	0,18
112 *	112	81	0,21
125	63	73	0,08
125	80	75	0,13
125	100	78	0,18
125 *	112	88	0,21
125	125	83	0,25
140	80	82	0,13
140	100	85	0,18
140 *	112	95	0,21
140 *	125	95	0,22
140	140	90	0,25
150	80	87	0,10
150	100	90	0,18
150	125	95	0,18
150	140	95	0,25
150	150	95	0,25
160	80	92	0,10
160	100	95	0,18
160	125	100	0,18
160	140	100	0,25
160	150	100	0,32
160	160	105	0,26
180	80	102	0,09
180	100	105	0,19

Ordering example

Product	PSU	125	100
Dimension Ød			
Dimension Ød ₃			

Saddle

PSU

Ød nom	Ød ₃ nom	l ₃ mm	m kg
180	125	110	0,25
180	140	110	0,25
180	150	110	0,22
180	160	115	0,27
180	180	115	0,48
200	80	112	0,09
200	100	115	0,19
200	125	115	0,25
200	140	120	0,25
200	150	120	0,22
200	160	125	0,27
200	180	125	0,45
200	200	125	0,39
224	80	124	0,12
224	100	127	0,18
224	125	132	0,23
224	140	132	0,29
224	150	132	0,21
224	160	137	0,24
224	180	137	0,41
224	200	137	0,47
224	224	137	0,64
250	80	137	0,12
250	100	140	0,18
250	125	145	0,23
250	140	145	0,29
250	150	145	0,21
250	160	150	0,24
250	180	150	0,41
250	200	150	0,47
250	224	150	0,63
250	250	150	0,80
280	80	155	0,12
280	100	155	0,12
280	125	160	0,23
280	140	160	0,27
280	150	160	0,21
280	160	165	0,24
280	180	165	0,40
280	200	165	0,46
280	224	165	0,58
280 *	250	165	0,77
280 *	280	165	0,59
300	80	162	0,12
300	100	165	0,12
300	125	170	0,23
300	140	170	0,27
300	150	170	0,21

Ød nom	Ød ₃ nom	l ₃ mm	m kg
300	160	175	0,24
300	180	175	0,40
300	200	175	0,46
300	224	175	0,58
300	250	175	0,71
300 *	280	175	0,59
300	300	175	1,13
315	80	170	0,12
315	100	173	0,12
315	125	178	0,23
315	140	178	0,27
315	150	178	0,21
315	160	182	0,24
315	180	182	0,40
315	200	182	0,46
315	224	182	0,58
315	250	182	0,71
315 *	280	182	0,95
315	300	182	1,10
315	315	182	1,22
355	100	193	0,12
355	125	198	0,23
355	140	198	0,27
355	150	198	0,21
355	160	203	0,24
355	180	203	0,40
355	200	203	0,44
355	224	203	0,58
355	250	203	0,65
355 *	280	203	0,89
355	300	203	0,94
355 *	315	203	1,12
355 *	355	203	0,90
400	100	215	0,12
400	125	220	0,23
400	150	220	0,24
400	160	225	0,24
400	200	225	0,44
400	224	225	0,54
400	250	225	0,65
400 *	280	225	0,83
400	300	250	0,94
400	315	225	1,03
400 *	355	225	1,42
400	400	225	1,87
450	100	240	0,12
450	125	245	0,23
450	150	245	0,24

Saddle

PSU

Ød nom	Ød ₃ nom	l ₃ mm	m kg
450	160	250	0,25
450	200	250	0,42
450	224	250	0,54
450	250	250	0,67
450 *	280	250	0,77
450	300	250	0,83
450	315	250	0,94
450 *	355	250	1,01
450	400	250	1,81
450 *	450	250	1,58
500	100	265	0,12
500	125	270	0,23
500	150	270	0,24
500	160	275	0,25
500	200	275	0,42
500	224	275	0,54
500	250	275	0,67
500	300	275	0,83
500	315	275	0,93
500 *	355	275	1,01
500	400	275	1,75
500 *	450	275	1,45
500 *	500	290	1,87
560	100	295	0,12
560	125	300	0,23
560	160	305	0,25
560	200	305	0,42
560	224	305	0,54
560	250	305	0,67
560	300	305	0,83
560	315	305	0,93
560 *	355	305	1,06
560	400	305	1,75
560 *	450	305	1,37
560 *	500	320	1,75
560 *	560	320	2,24
600	100	315	0,12
600	125	320	0,23
600	160	325	0,31
600	200	325	0,40
600	224	325	0,54
600	250	325	0,65
600	300	325	0,83
600	315	325	0,93
600 *	355	325	0,94
600	400	325	1,49
600 *	450	325	1,34
600 *	500	340	1,60

Ød nom	Ød ₃ nom	l ₃ mm	m kg
600 *	560	340	2,09
600 *	600	340	2,47
630	100	330	0,12
630	125	335	0,23
630	160	340	0,31
630	200	340	0,40
630	224	340	0,54
630	250	340	0,83
630	300	340	0,55
630	315	340	0,93
630 *	355	340	0,80
630	400	340	1,49
630 *	450	340	1,82
630 *	500	355	1,53
630 *	560	355	2,09
630 *	600	355	2,35
630 *	630	355	2,53

* Hand made

1

2

3

4

5

6

7

8

9

10

11

12

13

14

15

16

17

18

T-piece and saddle

T-CPU, PSU

Supply air

Diverging flow

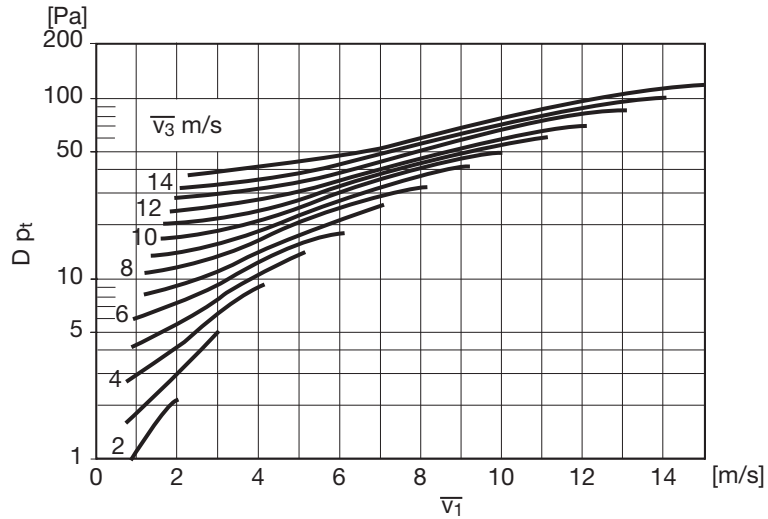
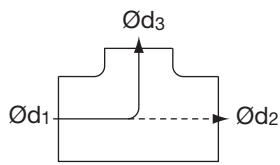

Diverging flow

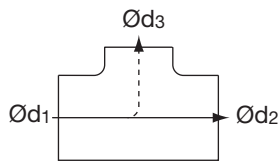

The diagram is also applicable to reduction in Ød_2 .

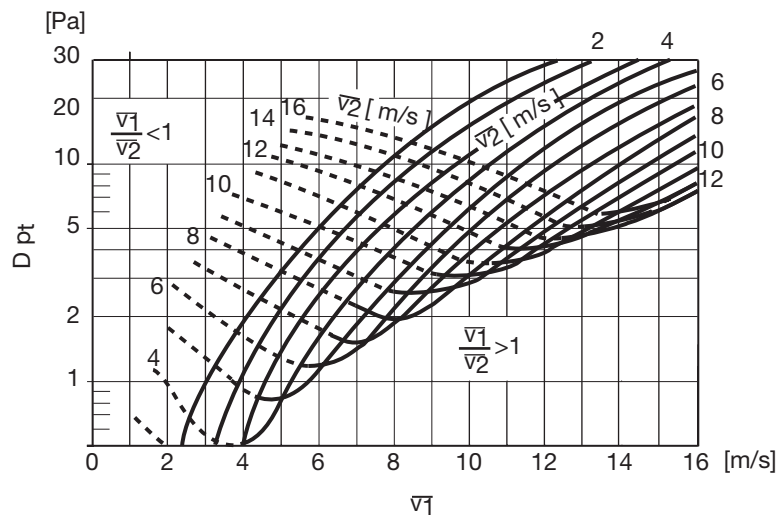

Diverging flow

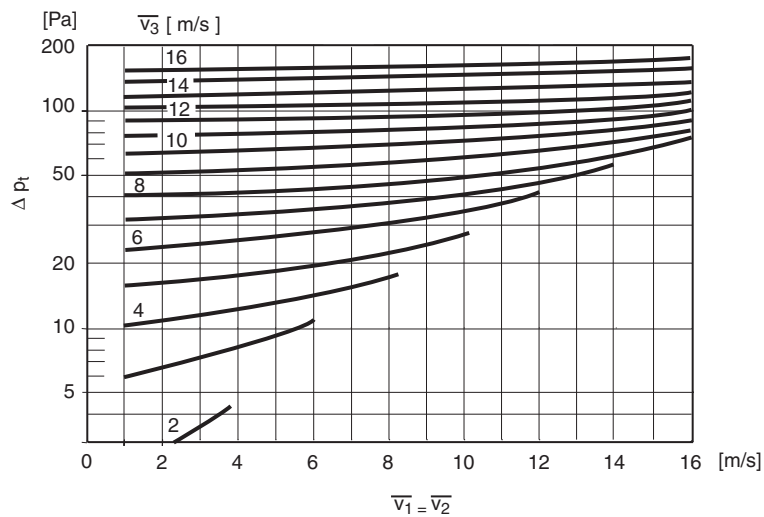
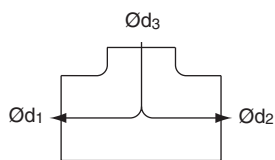

- 1
- 2
- 3
- 4
- 5
- 6
- 7
- 8
- 9
- 10
- 11
- 12
- 13
- 14
- 15
- 16
- 17
- 18

T-piece and saddle

T-CPU, PSU

Exhaust air

1

2

3

Converging flow

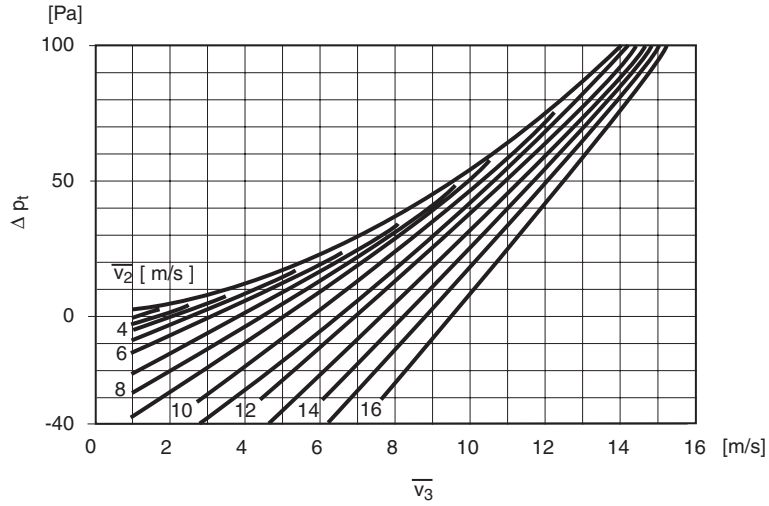
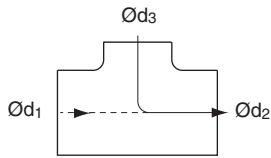

4

5

6

7

Converging flow

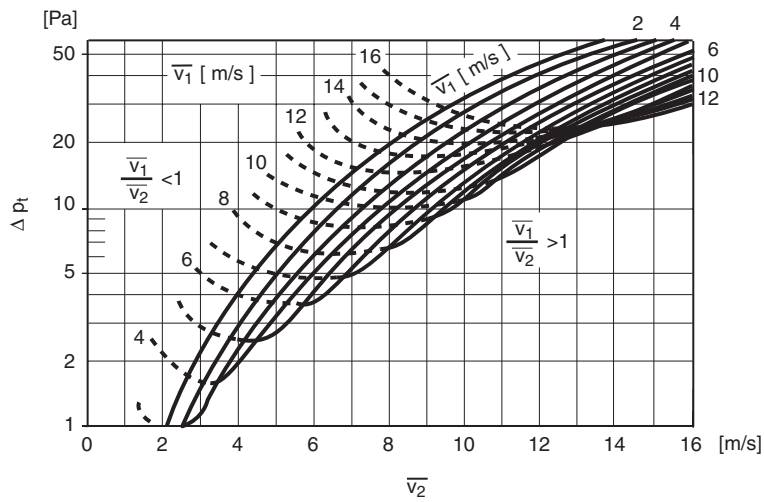
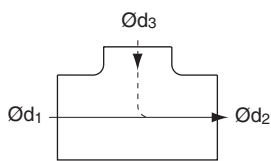

8

9

10

The diagram is also applicable to reduction in Ød_1 .

11

12

Converging flow

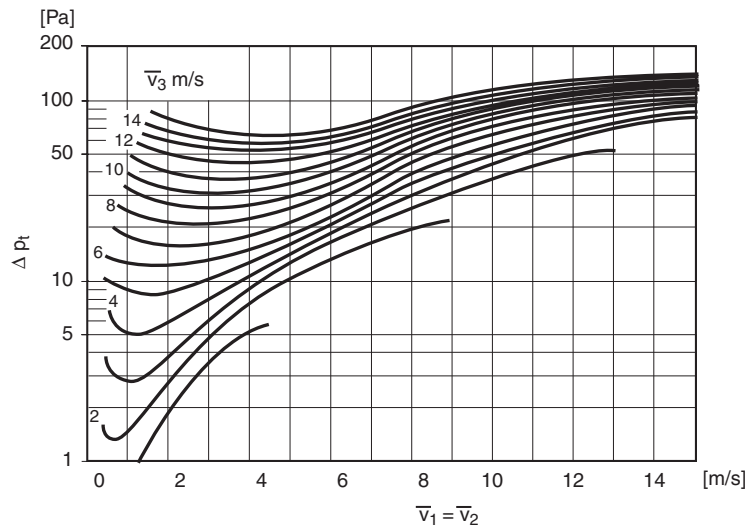
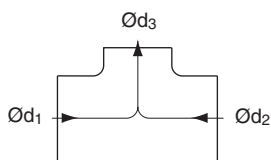

13

14

15

16

17

18