

Shut-off damper

DSU



Description

Has a turning, circular blade. The blade is stepless adjustable 0–90°. The damper is used when you have lower demands for shut-off capacity. The damper admits an insulation thickness of approx. 50 mm.

The damper can on occasions be used for regulation.

Setting angle α

$\alpha = 0^\circ =$ open blade, $\alpha = 90^\circ =$ closed blade

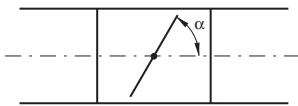

There is a separate assembly, measuring, balancing and maintenance instruction for this product.

Ø 63–1000 fullfills pressure class A in closed position.

The cup at Ø 80–630 can be complemented with the special insulation cup IK at insulation thicker than 50 mm.

Reinforced blade



Ordering example

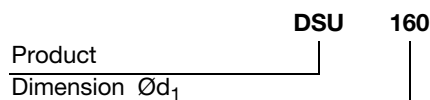

Dimensions

Ø 80–630

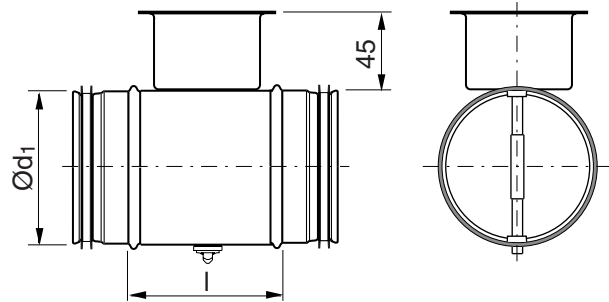

Ø 800–1000

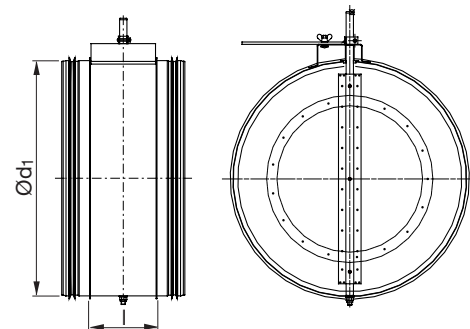

| Ød ₁ nom | l mm | m kg | Sealing class past closed blade |
|------------------------|---------|---------|------------------------------------|
| 63 | 100 | 0,30 | 0 |
| 80 | 100 | 0,35 | 0 |
| 100 | 100 | 0,40 | 0 |
| 112 | 100 | 0,44 | 0 |
| 125 | 100 | 0,49 | 0 |
| 140 | 100 | 0,54 | 0 |
| 150 | 100 | 0,57 | 0 |
| 160 | 100 | 0,67 | 0 |
| 180 | 100 | 0,73 | 0 |
| 200 | 100 | 0,86 | 0 |
| 224 | 100 | 1,10 | 0 |
| 250 | 100 | 1,31 | 0 |
| 280 | 100 | 1,51 | 0 |
| 300 | 100 | 1,65 | 0 |
| 315 | 100 | 1,81 | 0 |
| 355 | 100 | 2,00 | 0 |
| 400 | 100 | 2,91 | 1 |
| 450 | 100 | 3,90 | 1 |
| 500 | 115 | 4,92 | 1 |
| 560 | 115 | 6,01 | 1 |
| 600 | 115 | 6,40 | 1 |
| 630 | 115 | 6,92 | 1 |
| 800 | 230 | 19,0 | 1 |
| 1000 | 230 | 30,0 | 1 |

Shut-off damper

DSU

| Property | Ø 80-315 | Ø 400 | Ø 500 | Ø 630 | Ø 800-1000 |
|---|----------|-------|-------|-------|------------|
| The blade is set via a knob in a protective cup. | x | x | x | x | |
| The setting of the blade is read against an embossed scale at the rim of the cup. | x | x | x | x | |
| The blade is locked with two screws, type Pozidriv (PZD2). | x | x | x | x | |
| The blade has reinforced locking with a sturdy wing nut. | | | | | x |
| The blade is reinforced. | | x | x | x | |
| The blade is additionally reinforced. | | | | | x |
| With sturdy handle. | | x | x | x | |
| With additionally reinforced handle. | | | | | x |
| With reinforced stop beads. | | | x | x | |
| The axle is reinforced. | | | | | x |
| The damper can be delivered prepared for motor. | x | x | x | x | |
| The damper can be delivered with motor. | x | x | x | x | x |

Technical data

Pressure drop graphs with noise data for dimensioning

The solid curves show the pressure drop, Δp_t , over the damper as a function of flow q , and setting angle α .

The dashed curves give the A-weighted sound power data, L_{WA} , in dB to the duct.

Example

Given Dimension Ø100

Flow 60 l/s

Pressure drop 200 Pa

Obtained from graph

Setting angle 38°

Sound power level 63 dB (A)

Ø80

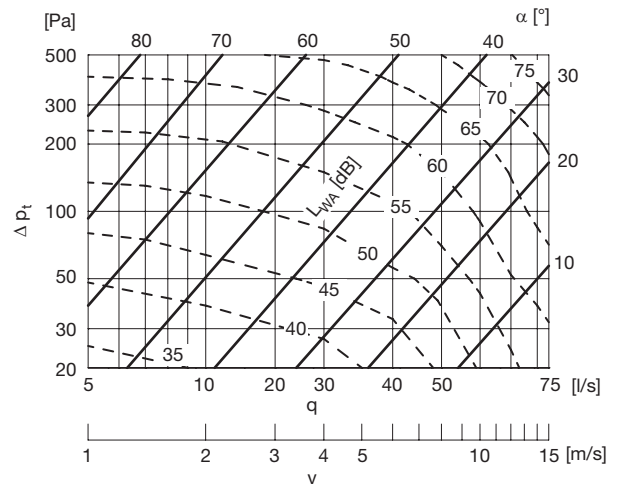

Ø100

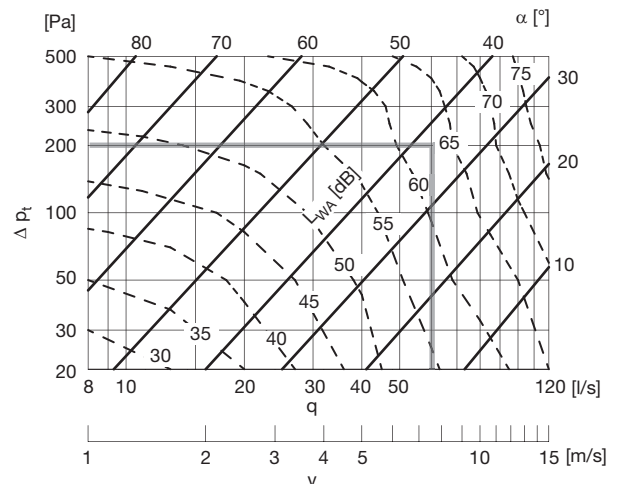

Shut-off damper

DSU

- 1
- 2
- 3
- 4
- 5
- 6
- 7
- 8
- 9
- 10
- 11
- 12
- 13
- 14
- 15
- 16
- 17
- 18

Ø125

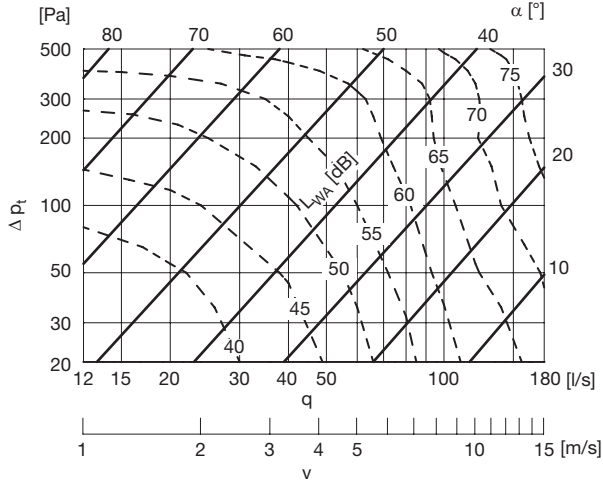

Ø250

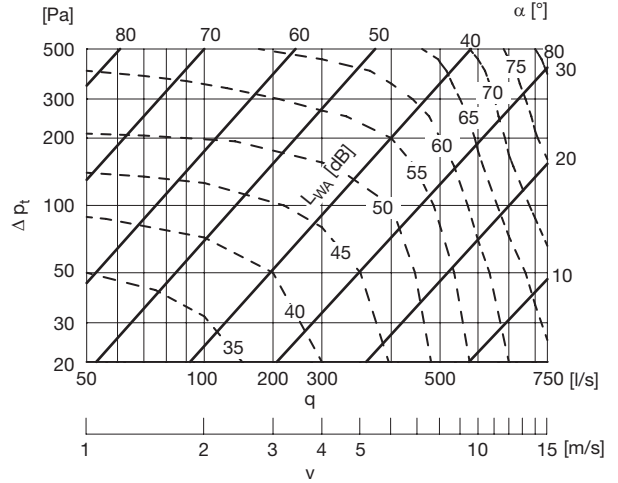

Ø160

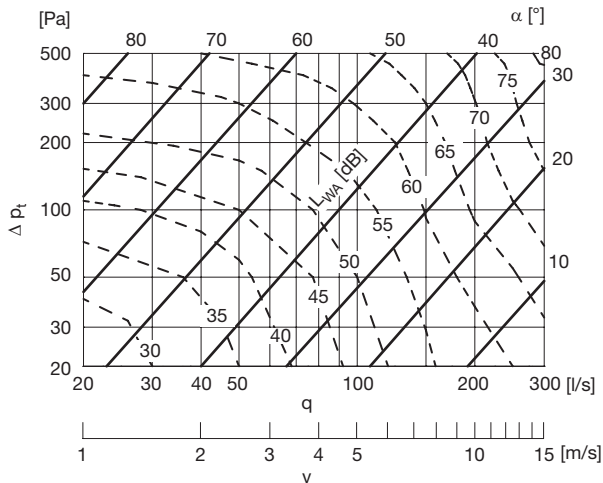

Ø315

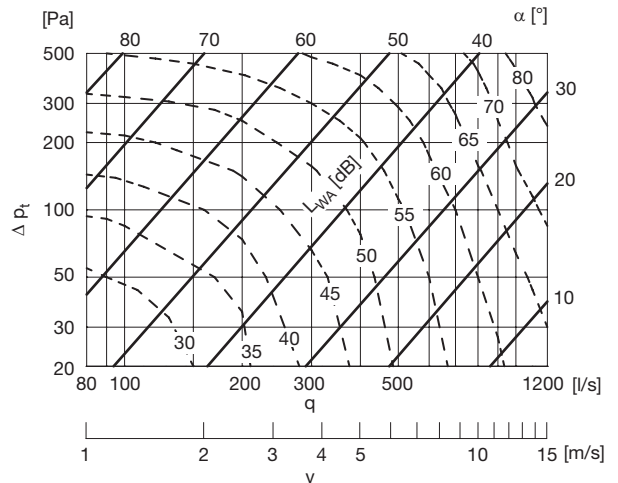

Ø200

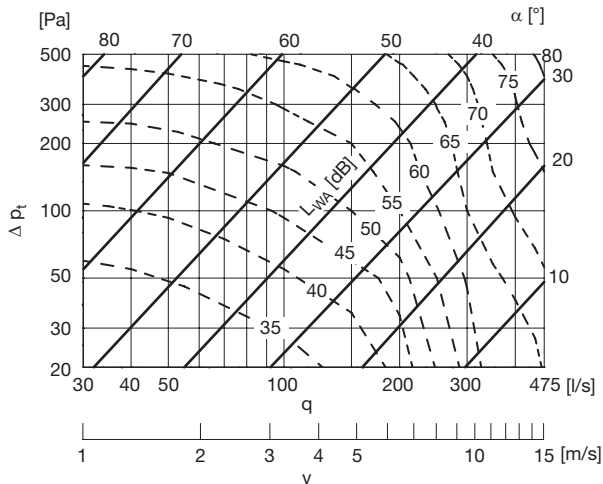

Ø400

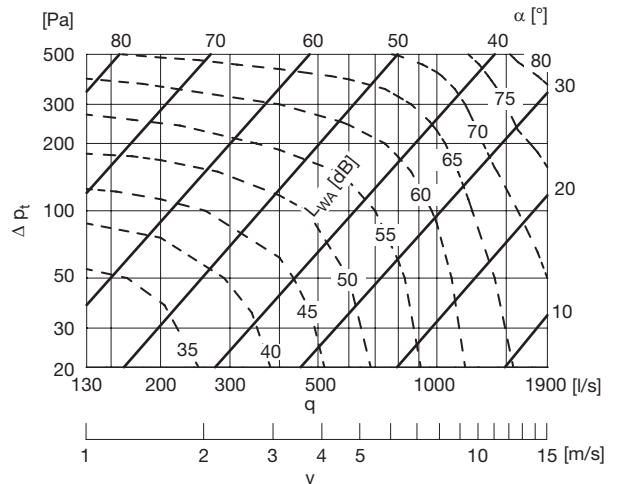

Shut-off damper

DSU

Ø500

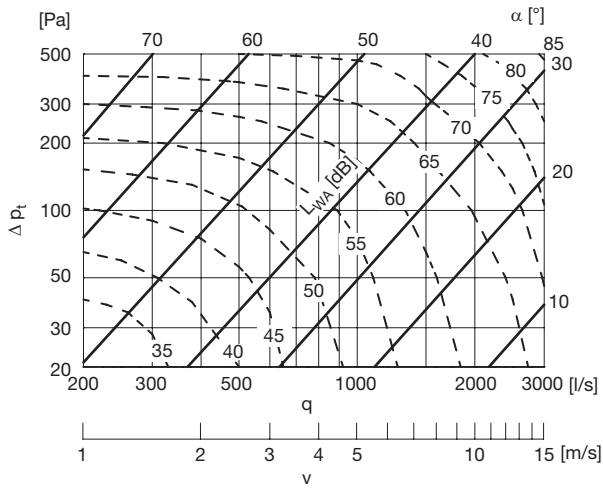

Ø1000

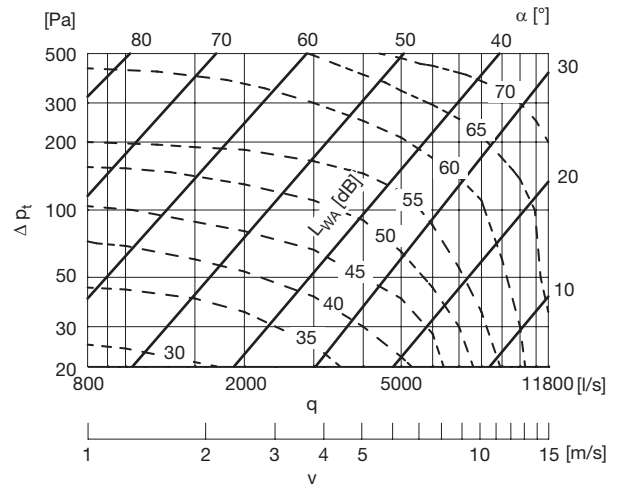

Ø630

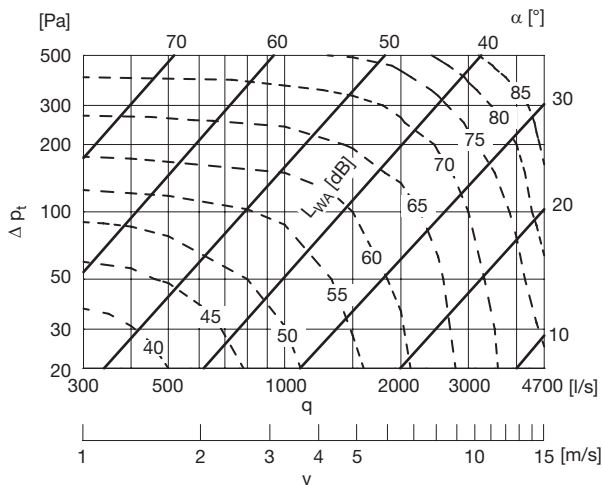

Ø800

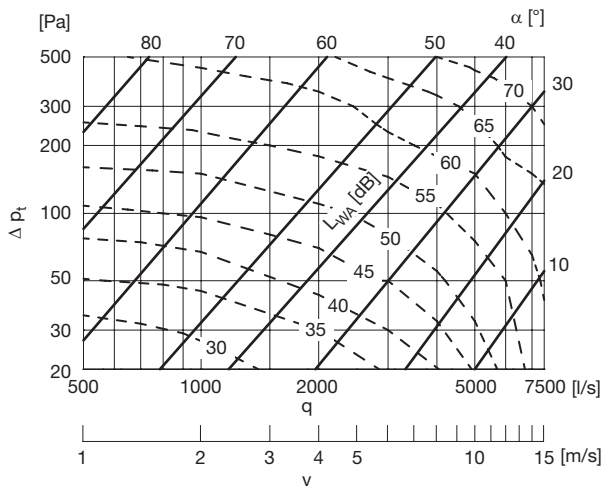

- 1
- 2
- 3
- 4
- 5
- 6
- 7
- 8
- 9
- 10
- 11
- 12
- 13
- 14
- 15
- 16
- 17
- 18

