

Bend

BU 60°

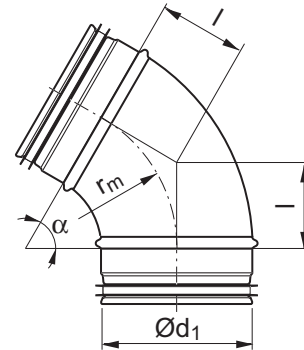

Dimensions



$$r_m \approx 1 \cdot d_1$$

Description

Pressed and seam welded bend.

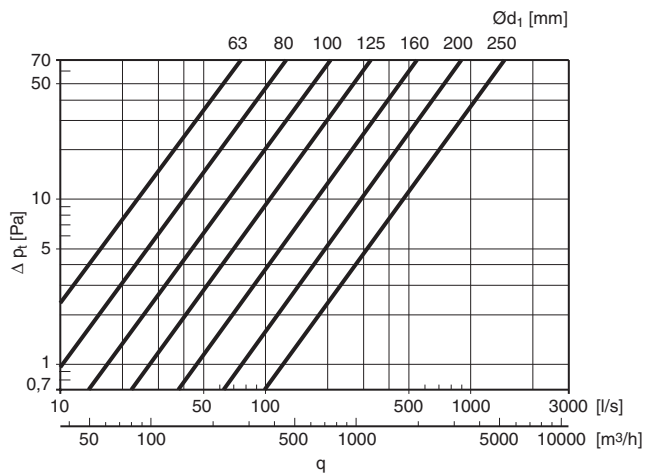

$\text{Ø}d_1$ nom	l mm	m kg
63	64	0,30
80	58	0,32
100	58	0,33
112	69	0,37
125	72	0,33
140	78	0,51
150	87	0,50
160	92	0,56
180	104	0,79
200	115	0,82
224	130	0,95
250	144	1,12

Ordering example

